

DATA SHEET

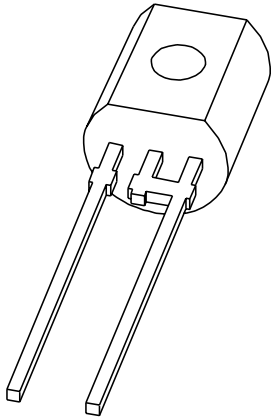

KTY81-2 series Silicon temperature sensors

Product specification
Supersedes data of 1996 Dec 06
File under Discrete Semiconductors, SC17

1998 Mar 26

Silicon temperature sensors

KTY81-2 series

DESCRIPTION

The temperature sensors in the KTY81-2 series have a positive temperature coefficient of resistance and are suitable for use in measurement and control systems. The sensors are encapsulated in the SOD70 leaded plastic package.

Tolerances of 0.5% or other special selections are available on request.

MARKING

TYPE NUMBER	CODE
KTY81-210	210
KTY81-220	220
KTY81-221	221
KTY81-222	222
KTY81-250	250
KTY81-251	251
KTY81-252	252

PINNING

PIN	DESCRIPTION
1	electrical contact
2	electrical contact
3	not to be connected to a potential

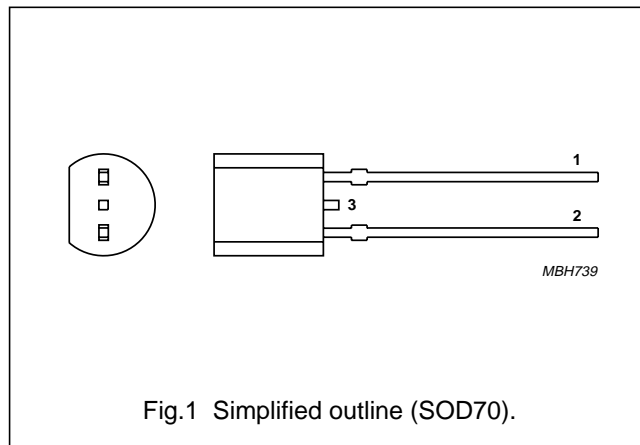

QUICK REFERENCE DATA

SYMBOL	PARAMETER	CONDITIONS	MIN.	MAX.	UNIT
R ₂₅	sensor resistance	T _{amb} = 25 °C; I _{cont} = 1 mA			
	KTY81-210		1980	2020	Ω
	KTY81-220		1960	2040	Ω
	KTY81-221		1960	2000	Ω
	KTY81-222		2000	2040	Ω
	KTY81-250		1900	2100	Ω
	KTY81-251		1900	2000	Ω
KTY81-252	2000	2100	Ω		
T _{amb}	ambient operating temperature		-55	+150	°C

Silicon temperature sensors

KTY81-2 series

LIMITING VALUES

In accordance with the Absolute Maximum Rating System (IEC 134).

SYMBOL	PARAMETER	CONDITIONS	MIN.	MAX.	UNIT
I_{cont}	continuous sensor current	in free air; $T_{\text{amb}} = 25\text{ °C}$	–	10	mA
		in free air; $T_{\text{amb}} = 150\text{ °C}$	–	2	mA
T_{amb}	ambient operating temperature		–55	+150	°C

CHARACTERISTICS

$T_{\text{amb}} = 25\text{ °C}$, in liquid, unless otherwise specified.

SYMBOL	PARAMETER	CONDITIONS	MIN.	TYP.	MAX.	UNIT
R_{25}	sensor resistance	$I_{\text{cont}} = 1\text{ mA}$				
	KTY81-210		1980	–	2020	Ω
	KTY81-220		1960	–	2040	Ω
	KTY81-221		1960	–	2000	Ω
	KTY81-222		2000	–	2040	Ω
	KTY81-250		1900	–	2100	Ω
	KTY81-251		1900	–	2000	Ω
KTY81-252	2000	–	2100	Ω		
TC	temperature coefficient		–	0.79	–	%/K
R_{100}/R_{25}	resistance ratio	$T_{\text{amb}} = 100\text{ °C}$ and 25 °C	1.676	1.696	1.716	
R_{-55}/R_{25}	resistance ratio	$T_{\text{amb}} = -55\text{ °C}$ and 25 °C	0.480	0.490	0.500	
τ	thermal time constant; note 1	in still air	–	30	–	s
		in still liquid; note 2	–	5	–	s
		in flowing liquid; note 2	–	3	–	s
	rated temperature range		–55	–	+150	°C

Notes

- The thermal time constant is the time taken for the sensor to reach 63.2% of the total temperature difference.
For example, if a sensor with a temperature of 25 °C is moved to an environment with an ambient temperature of 100 °C , the time for the sensor to reach a temperature of 72.4 °C is the thermal time constant.
- Inert liquid, e.g. FC43 manufactured by the 3M company.

Silicon temperature sensors

KTY81-2 series

Table 1 Ambient temperature, corresponding resistance, temperature coefficient and maximum expected temperature error for KTY81-210 and KTY81-220 $I_{\text{cont}} = 1 \text{ mA}$.

AMBIENT TEMPERATURE		TEMP. COEFF. (%/K)	KTY81-210				KTY81-220			
(°C)	(°F)		RESISTANCE (Ω)			TEMP. ERROR (K)	RESISTANCE (Ω)			TEMP. ERROR (K)
			MIN.	TYP.	MAX.		MIN.	TYP.	MAX.	
-55	-67	0.99	951	980	1009	±3.02	941	980	1019	±4.02
-50	-58	0.98	1000	1030	1059	±2.92	990	1030	1070	±3.94
-40	-40	0.96	1105	1135	1165	±2.74	1094	1135	1176	±3.78
-30	-22	0.93	1218	1247	1277	±2.55	1205	1247	1289	±3.62
-20	-4	0.91	1338	1367	1396	±2.35	1325	1367	1410	±3.45
-10	14	0.88	1467	1495	1523	±2.14	1452	1495	1538	±3.27
0	32	0.85	1603	1630	1656	±1.91	1587	1630	1673	±3.08
10	50	0.83	1748	1772	1797	±1.67	1730	1772	1814	±2.88
20	68	0.80	1901	1922	1944	±1.41	1881	1922	1963	±2.66
25	77	0.79	1980	2000	2020	±1.27	1960	2000	2040	±2.54
30	86	0.78	2057	2080	2102	±1.39	2036	2080	2123	±2.68
40	104	0.75	2217	2245	2272	±1.64	2194	2245	2295	±2.97
50	122	0.73	2383	2417	2451	±1.91	2359	2417	2475	±3.28
60	140	0.71	2557	2597	2637	±2.19	2531	2597	2663	±3.61
70	158	0.69	2737	2785	2832	±2.49	2709	2785	2860	±3.94
80	176	0.67	2924	2980	3035	±2.8	2894	2980	3065	±4.3
90	194	0.65	3118	3182	3246	±3.12	3086	3182	3278	±4.66
100	212	0.63	3318	3392	3466	±3.46	3284	3392	3500	±5.05
110	230	0.59	3523	3607	3691	±3.93	3487	3607	3728	±5.61
120	248	0.53	3722	3817	3912	±4.7	3683	3817	3950	±6.59
125	257	0.49	3815	3915	4016	±5.26	3775	3915	4055	±7.31
130	266	0.44	3901	4008	4114	±6	3861	4008	4154	±8.27
140	284	0.33	4049	4166	4283	±8.45	4008	4166	4325	±11.46
150	302	0.20	4153	4280	4407	±14.63	4110	4280	4450	±19.56

Silicon temperature sensors

KTY81-2 series

Table 2 Ambient temperature, corresponding resistance, temperature coefficient and maximum expected temperature error for KTY81-221 and KTY81-222 $I_{\text{cont}} = 1 \text{ mA}$.

AMBIENT TEMPERATURE		TEMP. COEFF. (%/K)	KTY81-221				KTY81-222			
(°C)	(°F)		RESISTANCE (Ω)			TEMP. ERROR (K)	RESISTANCE (Ω)			TEMP. ERROR (K)
			MIN.	TYP.	MAX.		MIN.	TYP.	MAX.	
-55	-67	0.99	941	970	999	±3.02	960	990	1020	±3.02
-50	-58	0.98	990	1019	1049	±2.92	1010	1040	1070	±2.92
-40	-40	0.96	1094	1123	1153	±2.74	1116	1146	1176	±2.74
-30	-22	0.93	1205	1235	1264	±2.55	1230	1260	1290	±2.55
-20	-4	0.91	1325	1354	1382	±2.35	1352	1381	1410	±2.35
-10	14	0.88	1452	1480	1508	±2.14	1481	1510	1538	±2.14
0	32	0.85	1587	1613	1640	±1.91	1619	1646	1673	±1.91
10	50	0.83	1730	1754	1779	±1.67	1765	1790	1815	±1.67
20	68	0.80	1882	1903	1924	±1.41	1920	1941	1963	±1.41
25	77	0.79	1960	1980	2000	±1.27	2000	2020	2040	±1.27
30	86	0.78	2037	2059	2081	±1.39	2078	2100	2123	±1.39
40	104	0.75	2195	2222	2250	±1.64	2239	2267	2295	±1.64
50	122	0.73	2360	2393	2426	±1.91	2407	2441	2475	±1.91
60	140	0.71	2531	2571	2611	±2.19	2582	2623	2664	±2.19
70	158	0.69	2710	2757	2804	±2.49	2764	2812	2860	±2.49
80	176	0.67	2895	2950	3005	±2.8	2953	3009	3065	±2.8
90	194	0.65	3086	3150	3214	±3.12	3149	3214	3279	±3.12
100	212	0.63	3285	3358	3431	±3.46	3351	3426	3501	±3.46
110	230	0.59	3488	3571	3655	±3.93	3558	3643	3728	±3.93
120	248	0.53	3684	3779	3873	±4.7	3759	3855	3951	±4.7
125	257	0.49	3776	3876	3976	±5.26	3853	3955	4056	±5.26
130	266	0.44	3862	3967	4073	±6	3940	4048	4155	±6
140	284	0.33	4009	4125	4241	±8.45	4090	4208	4326	±8.45
150	302	0.20	4112	4237	4363	±14.63	4195	4323	4451	±14.63

Silicon temperature sensors

KTY81-2 series

Table 3 Ambient temperature, corresponding resistance, temperature coefficient and maximum expected temperature error for KTY81-250 and KTY81-251 $I_{\text{cont}} = 1 \text{ mA}$.

AMBIENT TEMPERATURE		TEMP. COEFF. (%/K)	KTY81-250				KTY81-251			
(°C)	(°F)		RESISTANCE (Ω)			TEMP. ERROR (K)	RESISTANCE (Ω)			TEMP. ERROR (K)
			MIN.	TYP.	MAX.		MIN.	TYP.	MAX.	
-55	-67	0.99	911	980	1049	±7.04	913	956	999	±4.52
-50	-58	0.98	959	1030	1101	±6.99	960	1004	1048	±4.45
-40	-40	0.96	1060	1135	1210	±6.91	1061	1106	1152	±4.3
-30	-22	0.93	1168	1247	1327	±6.84	1169	1216	1263	±4.16
-20	-4	0.91	1283	1367	1451	±6.77	1285	1333	1381	±4.01
-10	14	0.88	1407	1495	1583	±6.69	1408	1457	1507	±3.84
0	32	0.85	1538	1630	1721	±6.61	1539	1589	1639	±3.67
10	50	0.83	1677	1772	1867	±6.51	1678	1728	1778	±3.48
20	68	0.80	1824	1922	2021	±6.41	1825	1874	1923	±3.28
25	77	0.79	1900	2000	2100	±6.35	1900	1950	2000	±3.18
30	86	0.78	1974	2080	2185	±6.55	1975	2028	2080	±3.33
40	104	0.75	2127	2245	2362	±6.97	2129	2189	2248	±3.64
50	122	0.73	2287	2417	2547	±7.4	2289	2357	2425	±3.97
60	140	0.71	2453	2597	2741	±7.85	2455	2532	2609	±4.31
70	158	0.69	2626	2785	2943	±8.31	2628	2715	2802	±4.67
80	176	0.67	2805	2980	3154	±8.79	2807	2905	3003	±5.05
90	194	0.65	2990	3182	3374	±9.29	2993	3102	3212	±5.43
100	212	0.63	3182	3392	3602	±9.81	3185	3307	3429	±5.84
110	230	0.59	3379	3607	3836	±10.65	3382	3517	3652	±6.45
120	248	0.53	3569	3817	4065	±12.25	3573	3721	3870	±7.53
125	257	0.49	3658	3915	4173	±13.45	3662	3817	3973	±8.33
130	266	0.44	3741	4008	4274	±15.06	3745	3907	4070	±9.4
140	284	0.33	3883	4166	4450	±20.49	3887	4062	4237	±12.96
150	302	0.20	3982	4280	4578	±34.35	3987	4173	4359	±22.02

Silicon temperature sensors

KTY81-2 series

Table 4 Ambient temperature, corresponding resistance, temperature coefficient and maximum expected temperature error for KTY81-252 $I_{\text{cont}} = 1 \text{ mA}$.

AMBIENT TEMPERATURE		TEMP. COEFF. (%/K)	KTY81-252			
(°C)	(°F)		RESISTANCE (Ω)			TEMP. ERROR (K)
			MIN.	TYP.	MAX.	
-55	-67	0.99	959	1005	1050	± 4.52
-50	-58	0.98	1009	1055	1102	± 4.45
-40	-40	0.96	1115	1163	1211	± 4.3
-30	-22	0.93	1229	1278	1328	± 4.16
-20	-4	0.91	1351	1401	1452	± 4.01
-10	14	0.88	1480	1532	1584	± 3.84
0	32	0.85	1618	1670	1723	± 3.67
10	50	0.83	1764	1817	1869	± 3.48
20	68	0.80	1919	1970	2022	± 3.28
25	77	0.79	2000	2050	2100	± 3.18
30	86	0.78	2077	2132	2187	± 3.33
40	104	0.75	2238	2301	2364	± 3.64
50	122	0.73	2406	2478	2549	± 3.97
60	140	0.71	2581	2662	2743	± 4.31
70	158	0.69	2763	2854	2946	± 4.67
80	176	0.67	2951	3054	3157	± 5.05
90	194	0.65	3147	3262	3376	± 5.43
100	212	0.63	3349	3477	3605	± 5.84
110	230	0.59	3556	3697	3839	± 6.45
120	248	0.53	3756	3912	4068	± 7.53
125	257	0.49	3850	4013	4177	± 8.33
130	266	0.44	3937	4108	4278	± 9.4
140	284	0.33	4087	4271	4455	± 12.96
150	302	0.20	4191	4387	4583	± 22.02

Silicon temperature sensors

KTY81-2 series

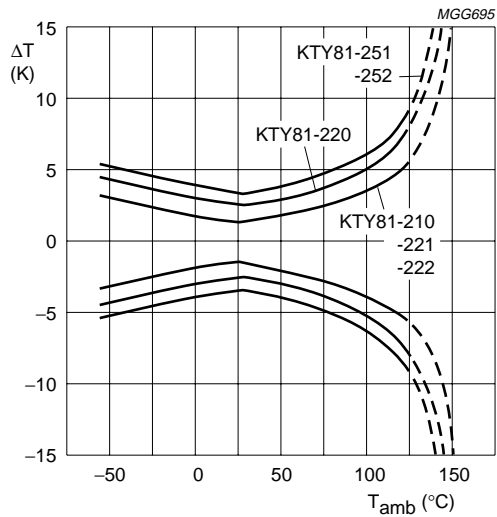
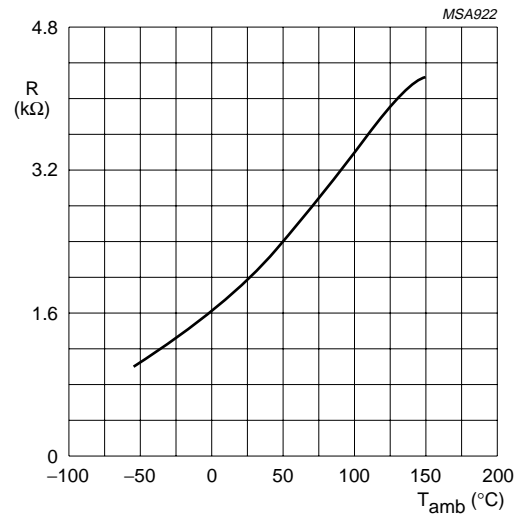
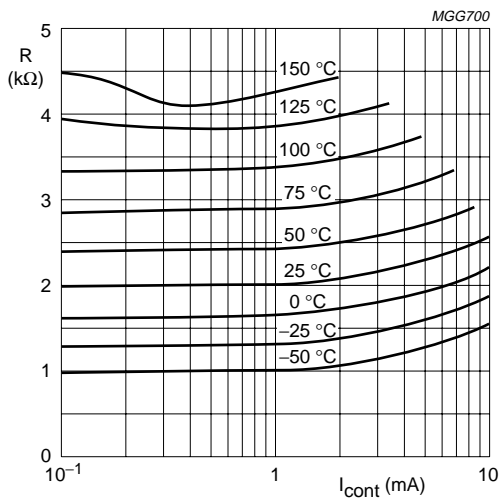

Fig.2 Maximum expected temperature error (ΔT).



$I_{cont} = 1 \text{ mA}$.

Fig.3 Sensor resistance as a function of ambient temperature; average values.



To keep the temperature error low, an operating current of $I_{cont} = 1 \text{ mA}$ is recommended for temperatures above 100 °C.

Fig.4 Sensor resistance as a function of operating current.

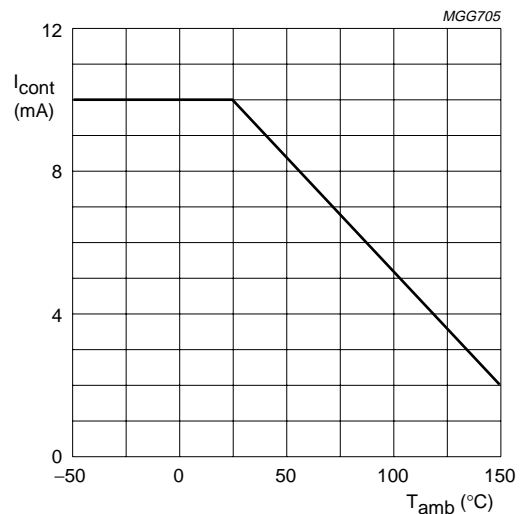
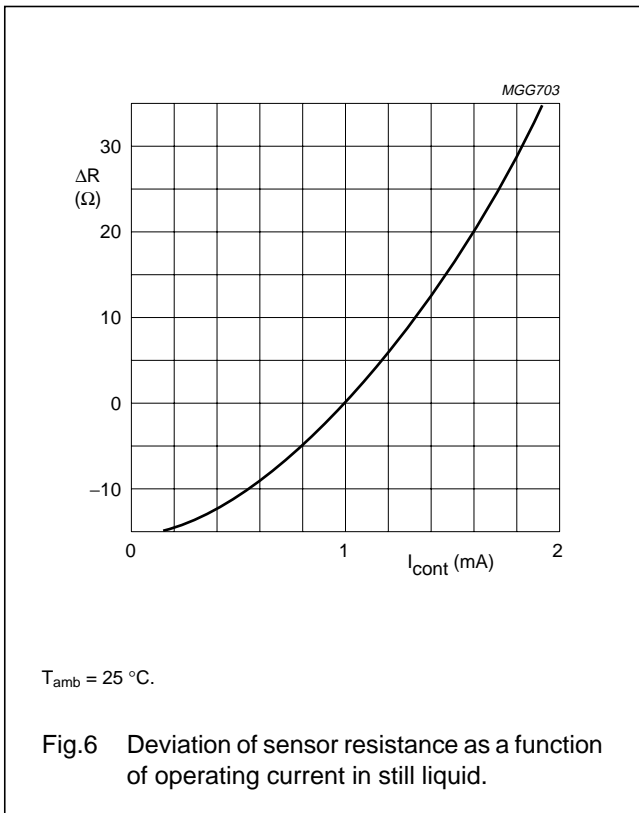

Fig.5 Maximum operating current for safe operation.

Silicon temperature sensors

KTY81-2 series



APPLICATION INFORMATION

SYMBOL	PARAMETER	CONDITIONS	TYP.	UNIT
ΔR_{25}	drift of sensor resistance at 25 °C	10000 hours continuous operation; $T_{amb} = 150\text{ }^{\circ}\text{C}$	0.5	Ω

Silicon temperature sensors

KTY81-2 series

PACKAGING

Sensors in SOD70 encapsulation are delivered in bulk packaging, and also reel packaging for automatic placement on hybrid circuits and printed-circuit boards (see Fig.7).

Note: Types in bulk packaging have a lead-to-lead distance of 2.54 millimetres, whereas the distance for types packaged on reel is 5.08 millimetres.

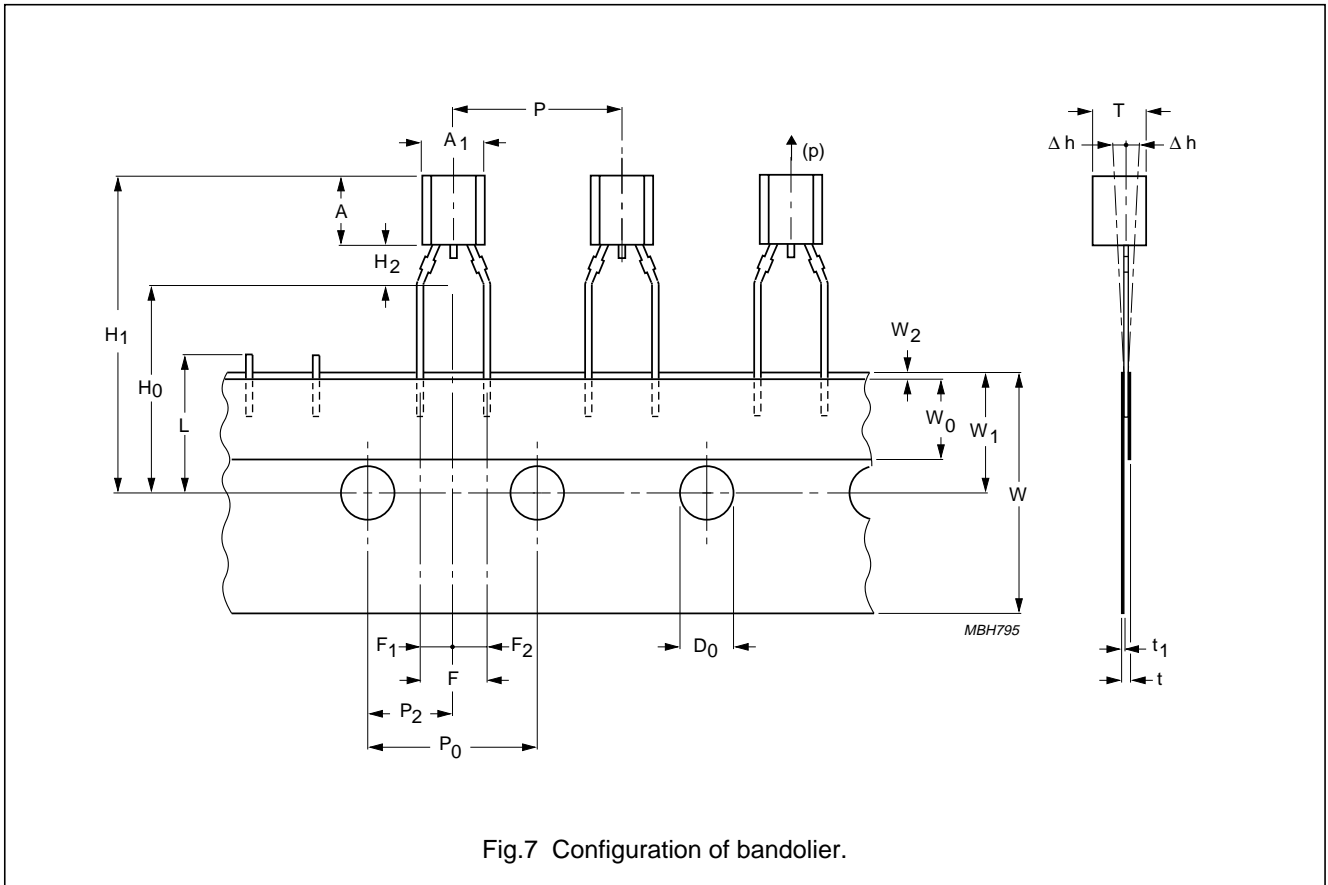

Fig.7 Configuration of bandolier.

Silicon temperature sensors

KTY81-2 series

Table 5 Tape specification

SYMBOL	DIMENSION	SPECIFICATIONS					REMARKS
		MIN.	NOM.	MAX.	TOL.	UNIT	
A ₁	body width	4.4	–	4.8	–	mm	
A	body height	5	–	5.2	–	mm	
T	body thickness	3.6	–	3.9	–	mm	
P	pitch of component	–	12.7	–	±1	mm	
P ₀	feed hole pitch	–	12.7	–	±0.3	mm	
	cumulative pitch error	–	–	–	±0.1		note 1
P ₂	feed hole centre to component centre	–	6.35	–	±0.4	mm	to be measured at bottom of clinch
F	lead-to-lead distance	–	5.08	–	+0.6/–0.2	mm	
Δh	component alignment	–	0	1	–	mm	at top of body
W	tape width	–	18	–	±0.5	mm	
W ₀	hold-down tape width	–	6	–	±0.2	mm	
W ₁	hole position	–	9	–	+0.7/–0.5	mm	
W ₂	hold-down tape position	–	0.5	–	±0.2	mm	
H ₀	lead wire clinch height	–	16.5	–	±0.5	mm	
H ₁	component height	–	–	23.25	–	mm	
L	length of snapped leads	–	–	11	–	mm	
D ₀	feed hole diameter	–	4	–	±0.2	mm	
t	total tape thickness	–	–	1.2	–	mm	t ₁ = 0.3 to 0.6
F ₁ , F ₂	lead to snapped lead distance	–	2.54	–	+0.4/–0.2	mm	
H ₂	clinch height	–	2.5	–	+0.5/0	mm	
(p)	pull-out force	6	–	–	–	N	

Note

1. Measured over 20 devices.

Silicon temperature sensors

KTY81-2 series

PACKAGE OUTLINE

Plastic near cylindrical single-ended package; 2 in-line leads

SOD70

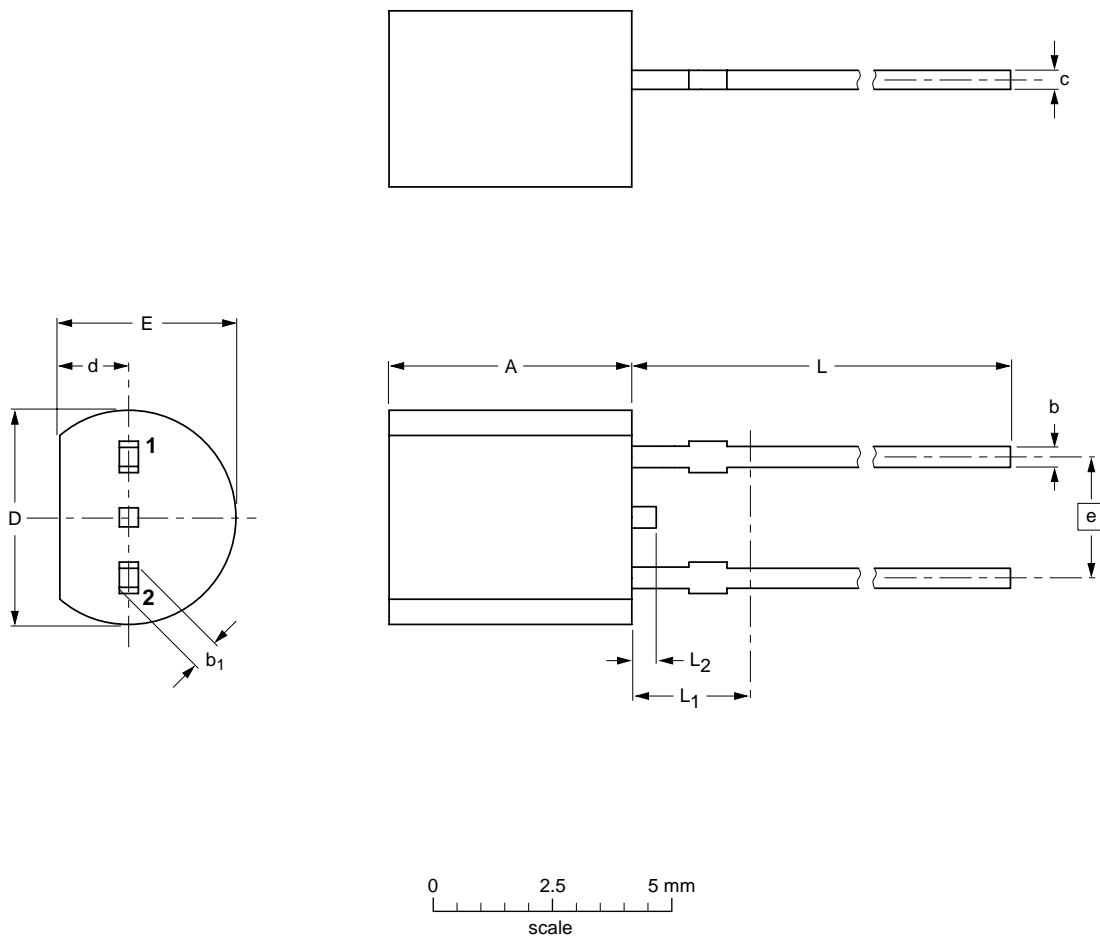

DIMENSIONS (mm are the original dimensions)

UNIT	A	b	b ₁	c	D	d	E	e	L	L ₁ ⁽¹⁾ max.	L ₂
mm	5.2 5.0	0.48 0.40	0.66 0.56	0.45 0.40	4.8 4.4	1.7 1.4	4.2 3.6	2.54	14.5 12.7	2.5	0.7 0.5

Notes

1. Terminal dimensions within this zone are uncontrolled to allow for flow of plastic and terminal irregularities.

OUTLINE VERSION	REFERENCES				EUROPEAN PROJECTION	ISSUE DATE
	IEC	JEDEC	EIAJ			
SOD70						97-05-30

Silicon temperature sensors

KTY81-2 series

DEFINITIONS

Data Sheet Status	
Objective specification	This data sheet contains target or goal specifications for product development.
Preliminary specification	This data sheet contains preliminary data; supplementary data may be published later.
Product specification	This data sheet contains final product specifications.
Limiting values	
Limiting values given are in accordance with the Absolute Maximum Rating System (IEC 134). Stress above one or more of the limiting values may cause permanent damage to the device. These are stress ratings only and operation of the device at these or at any other conditions above those given in the Characteristics sections of the specification is not implied. Exposure to limiting values for extended periods may affect device reliability.	
Application information	
Where application information is given, it is advisory and does not form part of the specification.	

LIFE SUPPORT APPLICATIONS

These products are not designed for use in life support appliances, devices, or systems where malfunction of these products can reasonably be expected to result in personal injury. Philips customers using or selling these products for use in such applications do so at their own risk and agree to fully indemnify Philips for any damages resulting from such improper use or sale.

Silicon temperature sensors

KTY81-2 series

NOTES

Silicon temperature sensors

KTY81-2 series

NOTES

Philips Semiconductors – a worldwide company

Argentina: see South America

Australia: 34 Waterloo Road, NORTH RYDE, NSW 2113,
Tel. +61 2 9805 4455, Fax. +61 2 9805 4466

Austria: Computerstr. 6, A-1101 WIEN, P.O. Box 213,
Tel. +43 1 60 101, Fax. +43 1 60 101 1210

Belarus: Hotel Minsk Business Center, Bld. 3, r. 1211, Volodarski Str. 6,
220050 MINSK, Tel. +375 172 200 733, Fax. +375 172 200 773

Belgium: see The Netherlands

Brazil: see South America

Bulgaria: Philips Bulgaria Ltd., Energoproject, 15th floor,
51 James Bourchier Blvd., 1407 SOFIA,
Tel. +359 2 689 211, Fax. +359 2 689 102

Canada: PHILIPS SEMICONDUCTORS/COMPONENTS,
Tel. +1 800 234 7381

China/Hong Kong: 501 Hong Kong Industrial Technology Centre,
72 Tat Chee Avenue, Kowloon Tong, HONG KONG,
Tel. +852 2319 7888, Fax. +852 2319 7700

Colombia: see South America

Czech Republic: see Austria

Denmark: Prags Boulevard 80, PB 1919, DK-2300 COPENHAGEN S,
Tel. +45 32 88 2636, Fax. +45 31 57 1949

Finland: Sinikalliontie 3, FIN-02630 ESPOO,
Tel. +358 9 615800, Fax. +358 9 61580/xxx

France: 4 Rue du Port-aux-Vins, BP317, 92156 SURESNES Cedex,
Tel. +33 1 40 99 6161, Fax. +33 1 40 99 6427

Germany: Hammerbrookstraße 69, D-20097 HAMBURG,
Tel. +49 40 23 53 60, Fax. +49 40 23 536 300

Greece: No. 15, 25th March Street, GR 17778 TAVROS/ATHENS,
Tel. +30 1 4894 339/239, Fax. +30 1 4814 240

Hungary: see Austria

India: Philips INDIA Ltd, Shivsagar Estate, A Block, Dr. Annie Besant Rd.
Worli, MUMBAI 400 018, Tel. +91 22 4938 541, Fax. +91 22 4938 722

Indonesia: see Singapore

Ireland: Newstead, Clonskeagh, DUBLIN 14,
Tel. +353 1 7640 000, Fax. +353 1 7640 200

Israel: RAPAC Electronics, 7 Kehilat Saloniki St, TEL AVIV 61180,
Tel. +972 3 645 0444, Fax. +972 3 649 1007

Italy: PHILIPS SEMICONDUCTORS, Piazza IV Novembre 3,
20124 MILANO, Tel. +39 2 6752 2531, Fax. +39 2 6752 2557

Japan: Philips Bldg 13-37, Kohnan 2-chome, Minato-ku, TOKYO 108,
Tel. +81 3 3740 5130, Fax. +81 3 3740 5077

Korea: Philips House, 260-199 Itaewon-dong, Yongsan-ku, SEOUL,
Tel. +82 2 709 1412, Fax. +82 2 709 1415

Malaysia: No. 76 Jalan Universiti, 46200 PETALING JAYA, SELANGOR,
Tel. +60 3 750 5214, Fax. +60 3 757 4880

Mexico: 5900 Gateway East, Suite 200, EL PASO, TEXAS 79905,
Tel. +9-5 800 234 7381

Middle East: see Italy

Netherlands: Postbus 90050, 5600 PB EINDHOVEN, Bldg. VB,
Tel. +31 40 27 82785, Fax. +31 40 27 88399

New Zealand: 2 Wagener Place, C.P.O. Box 1041, AUCKLAND,
Tel. +64 9 849 4160, Fax. +64 9 849 7811

Norway: Box 1, Manglerud 0612, OSLO,
Tel. +47 22 74 8000, Fax. +47 22 74 8341

Philippines: Philips Semiconductors Philippines Inc.,
106 Valero St. Salcedo Village, P.O. Box 2108 MCC, MAKATI,
Metro MANILA, Tel. +63 2 816 6380, Fax. +63 2 817 3474

Poland: Ul. Lukiska 10, PL 04-123 WARSZAWA,
Tel. +48 22 612 2831, Fax. +48 22 612 2327

Portugal: see Spain

Romania: see Italy

Russia: Philips Russia, Ul. Usatcheva 35A, 119048 MOSCOW,
Tel. +7 095 247 9145, Fax. +7 095 247 9144

Singapore: Lorong 1, Toa Payoh, SINGAPORE 1231,
Tel. +65 350 2538, Fax. +65 251 6500

Slovakia: see Austria

Slovenia: see Italy

South Africa: S.A. PHILIPS Pty Ltd., 195-215 Main Road Martindale,
2092 JOHANNESBURG, P.O. Box 7430 Johannesburg 2000,
Tel. +27 11 470 5911, Fax. +27 11 470 5494

South America: Rua do Rocio 220, 5th floor, Suite 51,
04552-903 São Paulo, SÃO PAULO - SP, Brazil,
Tel. +55 11 821 2333, Fax. +55 11 829 1849

Spain: Balmes 22, 08007 BARCELONA,
Tel. +34 3 301 6312, Fax. +34 3 301 4107

Sweden: Kottbygatan 7, Akalla, S-16485 STOCKHOLM,
Tel. +46 8 632 2000, Fax. +46 8 632 2745

Switzerland: Allmendstrasse 140, CH-8027 ZÜRICH,
Tel. +41 1 488 2686, Fax. +41 1 481 7730

Taiwan: PHILIPS TAIWAN Ltd., 23-30F, 66,
Chung Hsiao West Road, Sec. 1, P.O. Box 22978,
TAIPEI 100, Tel. +886 2 382 4443, Fax. +886 2 382 4444

Thailand: PHILIPS ELECTRONICS (THAILAND) Ltd.,
209/2 Sanpavuth-Bangna Road Prakanong, BANGKOK 10260,
Tel. +66 2 745 4090, Fax. +66 2 398 0793

Turkey: Talatpasa Cad. No. 5, 80640 GÜLTEPE/ISTANBUL,
Tel. +90 212 279 2770, Fax. +90 212 282 6707

Ukraine: PHILIPS UKRAINE, 4 Patrice Lumumba str., Building B, Floor 7,
252042 KIEV, Tel. +380 44 264 2776, Fax. +380 44 268 0461

United Kingdom: Philips Semiconductors Ltd., 276 Bath Road, Hayes,
MIDDLESEX UB3 5BX, Tel. +44 181 730 5000, Fax. +44 181 754 8421

United States: 811 East Arques Avenue, SUNNYVALE, CA 94088-3409,
Tel. +1 800 234 7381

Uruguay: see South America

Vietnam: see Singapore

Yugoslavia: PHILIPS, Trg N. Pasica 5/v, 11000 BEOGRAD,
Tel. +381 11 625 344, Fax. +381 11 635 777

For all other countries apply to: Philips Semiconductors, Marketing & Sales Communications,
Building BE-p, P.O. Box 218, 5600 MD EINDHOVEN, The Netherlands, Fax. +31 40 27 24825

Internet: <http://www.semiconductors.philips.com>

© Philips Electronics N.V. 1996

SCA52

All rights are reserved. Reproduction in whole or in part is prohibited without the prior written consent of the copyright owner.

The information presented in this document does not form part of any quotation or contract, is believed to be accurate and reliable and may be changed without notice. No liability will be accepted by the publisher for any consequence of its use. Publication thereof does not convey nor imply any license under patent- or other industrial or intellectual property rights.

Printed in The Netherlands

115106/00/03/pp16

Date of release: 1998 Mar 26

Document order number: 9397 750 03623

Let's make things better.

Philips
Semiconductors



PHILIPS

SUNSTAR 商斯达实业集团是集研发、生产、工程、销售、代理经销、技术咨询、信息服务等为一体的高科技企业，是专业高科技电子产品生产厂家，是具有 10 多年历史的专业电子元器件供应商，是中国最早和最大的仓储式连锁规模经营大型综合电子零部件代理分销商之一，是一家专业代理和分销世界各大品牌 IC 芯片和电子元器件的连锁经营综合性国际公司，专业经营进口、国产名厂名牌电子元件，型号、种类齐全。在香港、北京、深圳、上海、西安、成都等全国主要电子市场设有直属分公司和产品展示展销窗口门市部专卖店及代理分销商，已在全国范围内建成强大统一的供货和代理分销网络。我们专业代理经销、开发生产电子元器件、集成电路、传感器、微波光电元器件、工控机/DOC/DOM 电子盘、专用电路、单片机开发、MCU/DSP/ARM/FPGA 软件硬件、二极管、三极管、模块等，是您可靠的一站式现货配套供应商、方案提供商、部件功能模块开发配套商。商斯达实业公司拥有庞大的资料库，有数位毕业于著名高校——有中国电子工业摇篮之称的西安电子科技大学（西军电）并长期从事国防尖端科技研究的高级工程师为您精挑细选、量身订做各种高科技电子元器件，并解决各种技术问题。

微波光电部专业代理经销高频、微波、光纤、光电元器件、组件、部件、模块、整机；电磁兼容元器件、材料、设备；微波 CAD、EDA 软件、开发测试仿真工具；微波、光纤仪器仪表。欢迎国外高科技微波、光纤厂商将优秀产品介绍到中国、共同开拓市场。长期大量现货专业批发高频、微波、卫星、光纤、电视、CATV 器件：晶振、VCO、连接器、PIN 开关、变容二极管、开关二极管、低噪晶体管、功率电阻及电容、放大器、功率管、MMIC、混频器、耦合器、功分器、振荡器、合成器、衰减器、滤波器、隔离器、环行器、移相器、调制解调器；光电子元件和组件：红外发射管、红外接收管、光电开关、光敏管、发光二极管和发光二极管组件、半导体激光二极管和激光器组件、光电探测器和光接收组件、光发射接收模块、光纤激光器和光放大器、光调制器、光开关、DWDM 用光发射和接收器件、用户接入系统光收发器件与模块、光纤连接器、光纤跳线/尾纤、光衰减器、光纤适配器、光隔离器、光耦合器、光环行器、光复用器/转换器；无线收发芯片和模组、蓝牙芯片和模组。

更多产品请看本公司产品专用销售网站：

商斯达中国传感器科技信息网：<http://www.sensor-ic.com/>

商斯达工控安防网：<http://www.pc-ps.net/>

商斯达电子元器件网：<http://www.sunstare.com/>

商斯达微波光电产品网：[HTTP://www.rfoe.net/](http://www.rfoe.net/)

商斯达消费电子产品网：<http://www.icasic.com/>

商斯达实业科技产品网：<http://www.sunstars.cn/> 微波元器件销售热线：

地址：深圳市福田区福华路福庆街鸿图大厦 1602 室

电话：0755-82884100 83397033 83396822 83398585

传真：0755-83376182 (0) 13823648918 MSN: SUNS8888@hotmail.com

邮编：518033 E-mail:szss20@163.com QQ: 195847376

深圳赛格展销部：深圳华强北路赛格电子市场 2583 号 电话：0755-83665529 25059422

技术支持：0755-83394033 13501568376

欢迎索取免费详细资料、设计指南和光盘；产品凡多，未能尽录，欢迎来电查询。

北京分公司：北京海淀区知春路 132 号中发电子大厦 3097 号

TEL: 010-81159046 82615020 13501189838 FAX: 010-62543996

上海分公司：上海市北京东路 668 号上海赛格电子市场 D125 号

TEL: 021-28311762 56703037 13701955389 FAX: 021-56703037

西安分公司：西安高新开发区 20 所(中国电子科技集团导航技术研究所)

西安劳动南路 88 号电子商城二楼 D23 号

TEL: 029-81022619 13072977981 FAX:029-88789382