

# DATA SHEET

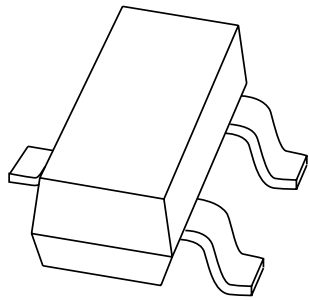

**PMBD7000**

High-speed double diode

Product specification  
Supersedes data of 1996 Sep 18

1999 May 11

# High-speed double diode

# PMBD7000

### FEATURES

- Small plastic SMD package
- High switching speed: max. 4 ns
- Continuous reverse voltage: max. 100 V
- Repetitive peak reverse voltage: max. 100 V
- Repetitive peak forward current: max. 450 mA.

### APPLICATIONS

- High-speed switching in e.g. surface mounted circuits.

### DESCRIPTION

The PMBD7000 consists of two high-speed switching diodes connected in series, fabricated in planar technology, and encapsulated in the small SOT23 plastic SMD package.

### PINNING

PIN	DESCRIPTION
1	anode
2	cathode
3	common connection

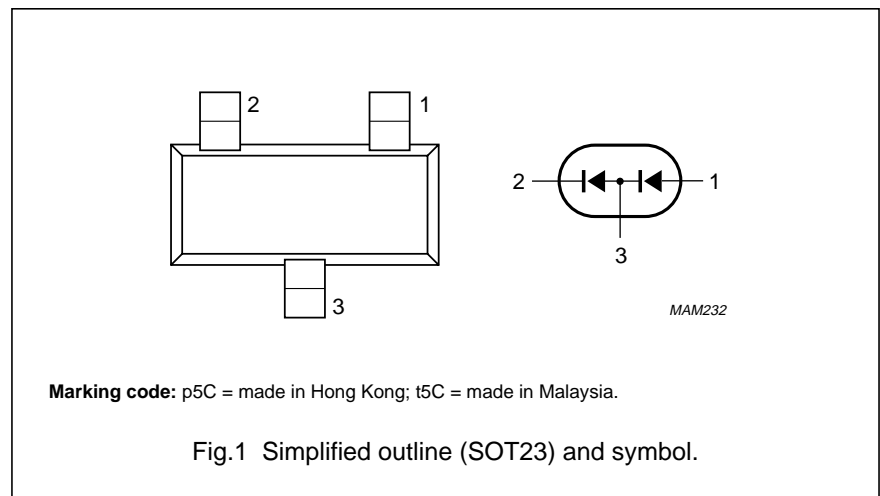

### LIMITING VALUES

In accordance with the Absolute Maximum Rating System (IEC 134).

SYMBOL	PARAMETER	CONDITIONS	MIN.	MAX.	UNIT
<b>Per diode</b>					
$V_{RRM}$	repetitive peak reverse voltage		–	100	V
$V_R$	continuous reverse voltage		–	100	V
$I_F$	continuous forward current	single diode loaded; see Fig.2; note 1	–	215	mA
		double diode loaded; see Fig.2; note 1	–	125	mA
$I_{FRM}$	repetitive peak forward current		–	450	mA
$I_{FSM}$	non-repetitive peak forward current	square wave; $T_j = 25\text{ °C}$ prior to surge; see Fig.4			
		$t = 1\ \mu\text{s}$	–	4	A
		$t = 1\ \text{ms}$	–	1	A
		$t = 1\ \text{s}$	–	0.5	A
$P_{tot}$	total power dissipation	$T_{amb} = 25\text{ °C}$ ; note 1	–	250	mW
$T_{stg}$	storage temperature		–65	+150	°C
$T_j$	junction temperature		–	150	°C

### Note

1. Device mounted on an FR4 printed-circuit board.

## High-speed double diode

## PMBD7000

**ELECTRICAL CHARACTERISTICS**

$T_j = 25\text{ }^\circ\text{C}$  unless otherwise specified.

SYMBOL	PARAMETER	CONDITIONS	MIN.	MAX.	UNIT
<b>Per diode</b>					
$V_F$	forward voltage	see Fig.3			
		$I_F = 1\text{ mA}$	550	700	mV
		$I_F = 10\text{ mA}$	670	820	mV
		$I_F = 50\text{ mA}$	–	1	V
		$I_F = 100\text{ mA}$	0.75	1.1	V
		$I_F = 150\text{ mA}$	–	1.25	mV
$I_R$	reverse current	see Fig.5			
		$V_R = 50\text{ V}$	–	300	nA
		$V_R = 100\text{ V}$	–	500	nA
		$V_R = 50\text{ V}; T_j = 150\text{ }^\circ\text{C}$	–	100	$\mu\text{A}$
$C_d$	diode capacitance	$f = 1\text{ MHz}; V_R = 0$ ; see Fig.6	–	1.5	pF
$t_{rr}$	reverse recovery time	when switched from $I_F = 10\text{ mA}$ to $I_R = 10\text{ mA}; R_L = 100\ \Omega$ ; measured at $I_R = 1\text{ mA}$ ; see Fig.7	–	4	ns
$V_{fr}$	forward recovery voltage	when switched from $I_F = 10\text{ mA}$ ; $t_r = 20\text{ ns}$ ; see Fig.8	–	1.75	V

**THERMAL CHARACTERISTICS**

SYMBOL	PARAMETER	CONDITIONS	VALUE	UNIT
$R_{th\ j-tp}$	thermal resistance from junction to tie-point		360	K/W
$R_{th\ j-a}$	thermal resistance from junction to ambient	note 1	500	K/W

**Note**

1. Device mounted on an FR4 printed-circuit board.

High-speed double diode

PMBD7000

GRAPHICAL DATA

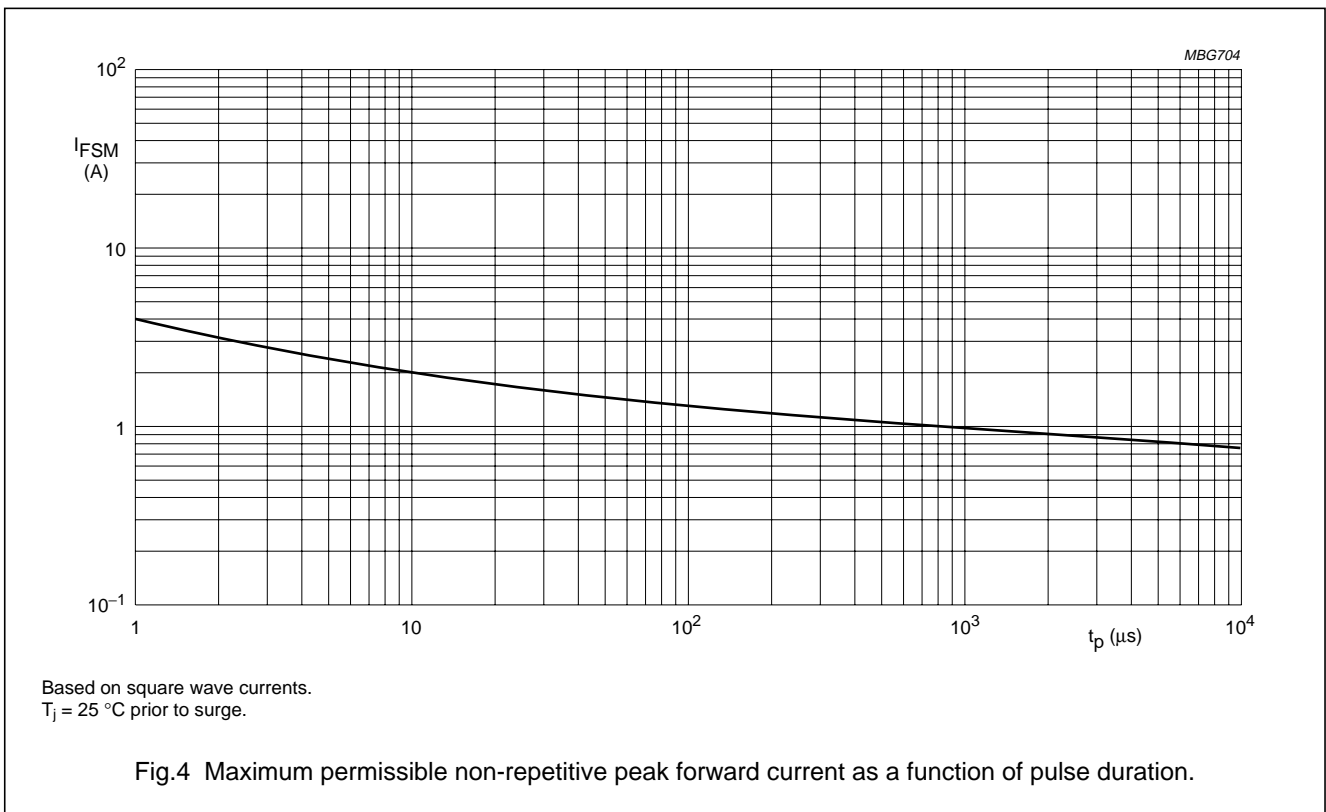
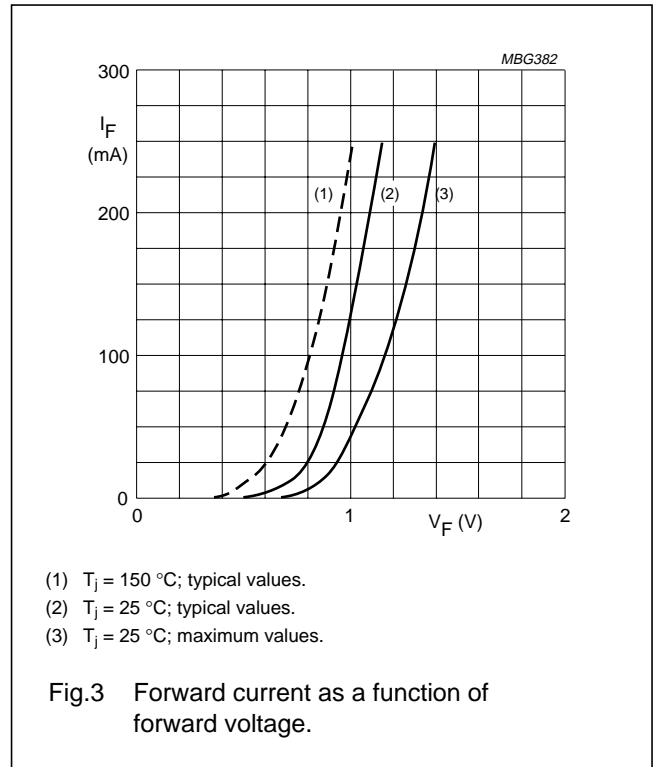
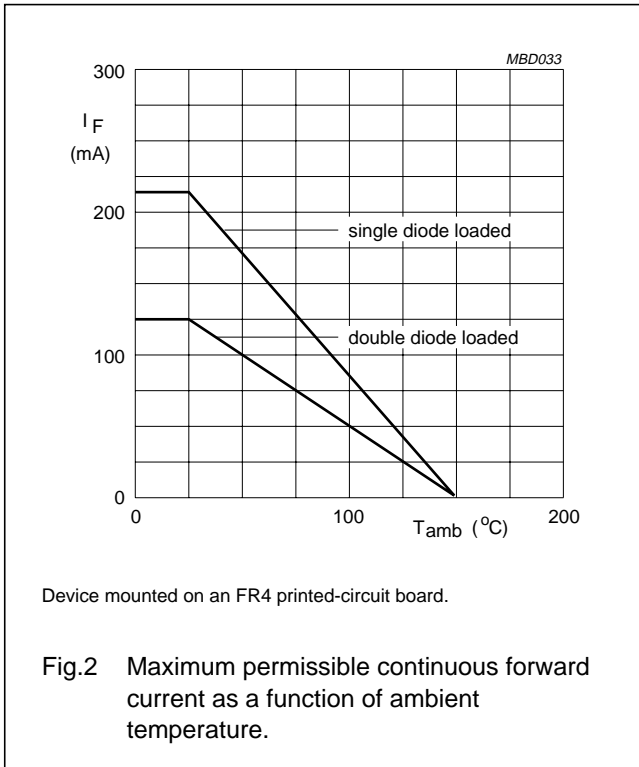

High-speed double diode

PMBD7000

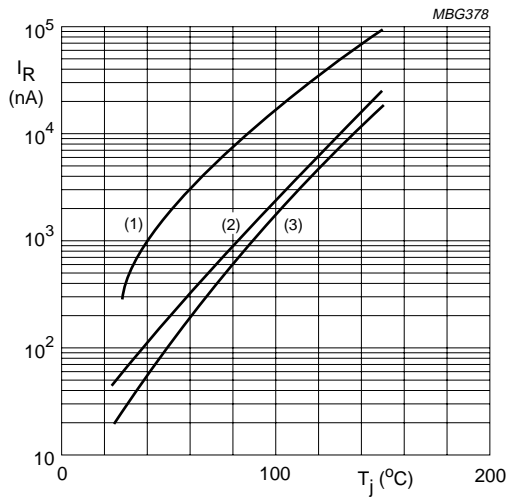

- (1)  $V_R = 50$  V; maximum values.
- (2)  $V_R = 30$  V; typical values.
- (3)  $V_R = 50$  V; typical values.

Fig.5 Reverse current as a function of junction temperature.

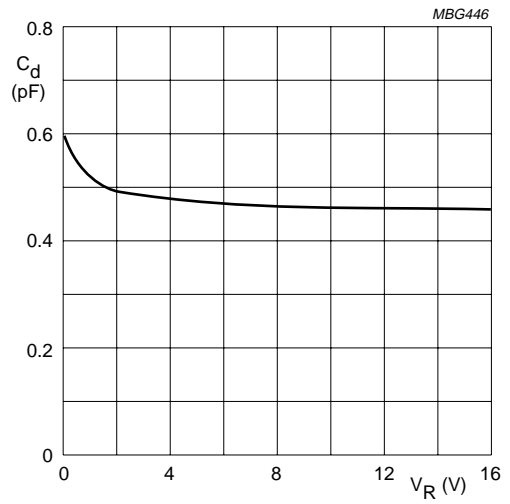

$f = 1$  MHz;  $T_j = 25$  °C.

Fig.6 Diode capacitance as a function of reverse voltage; typical values.

High-speed double diode

PMBD7000

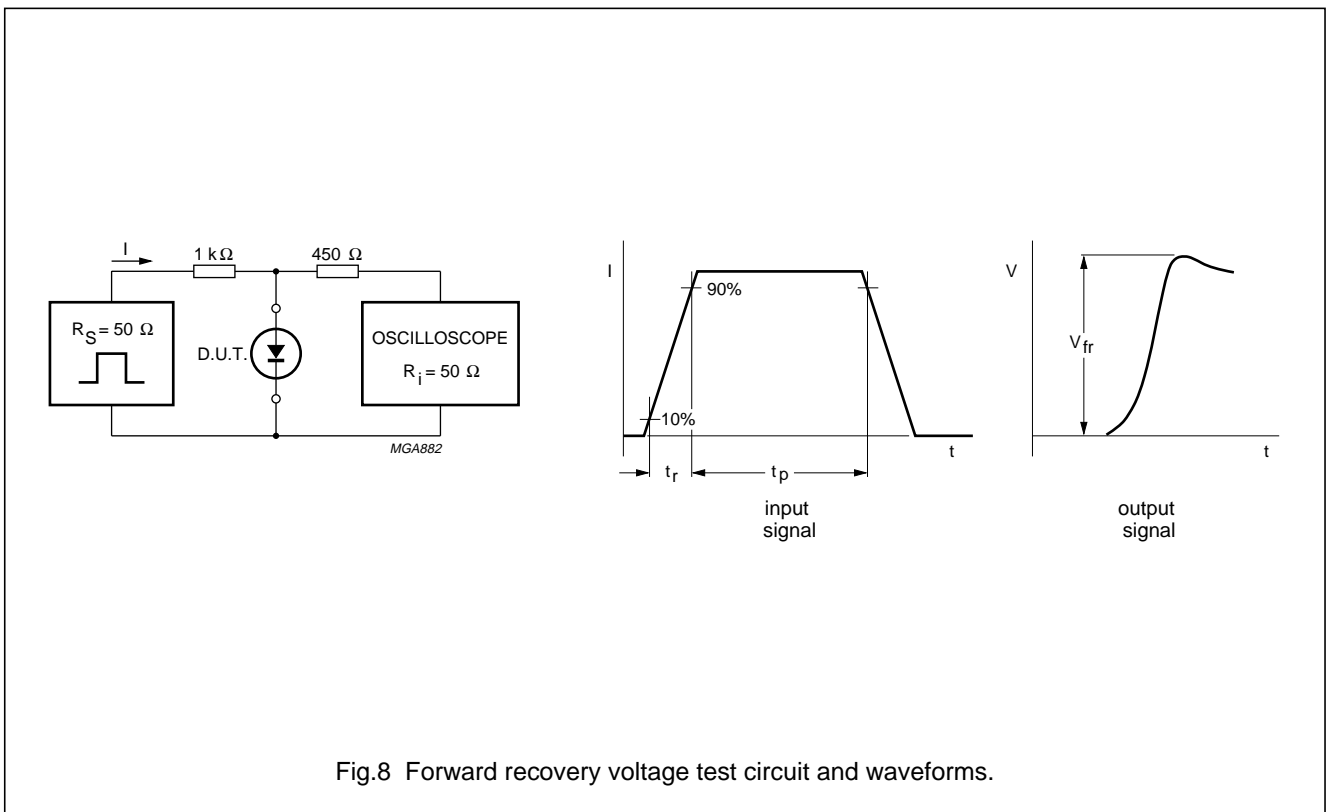
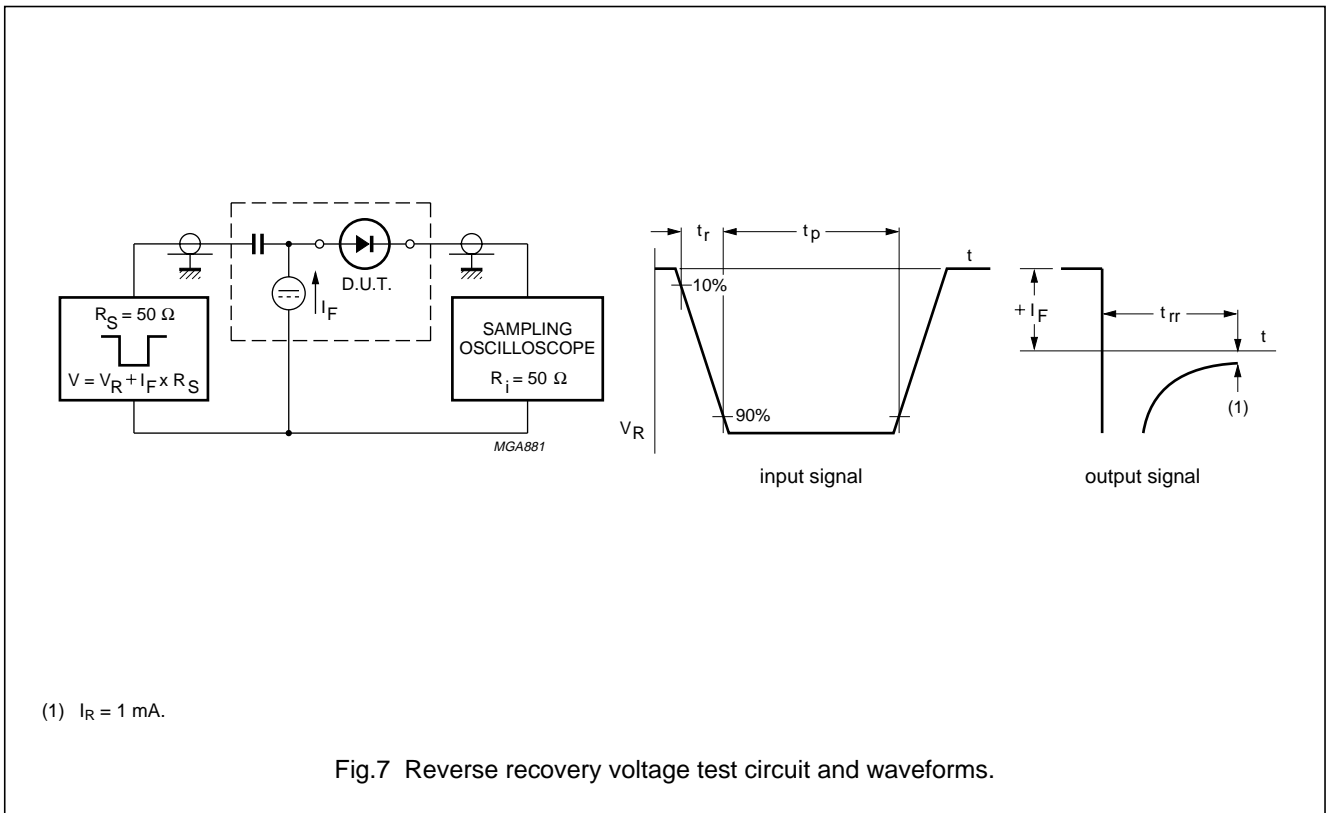

# High-speed double diode

PMBD7000

## PACKAGE OUTLINE

Plastic surface mounted package; 3 leads

SOT23

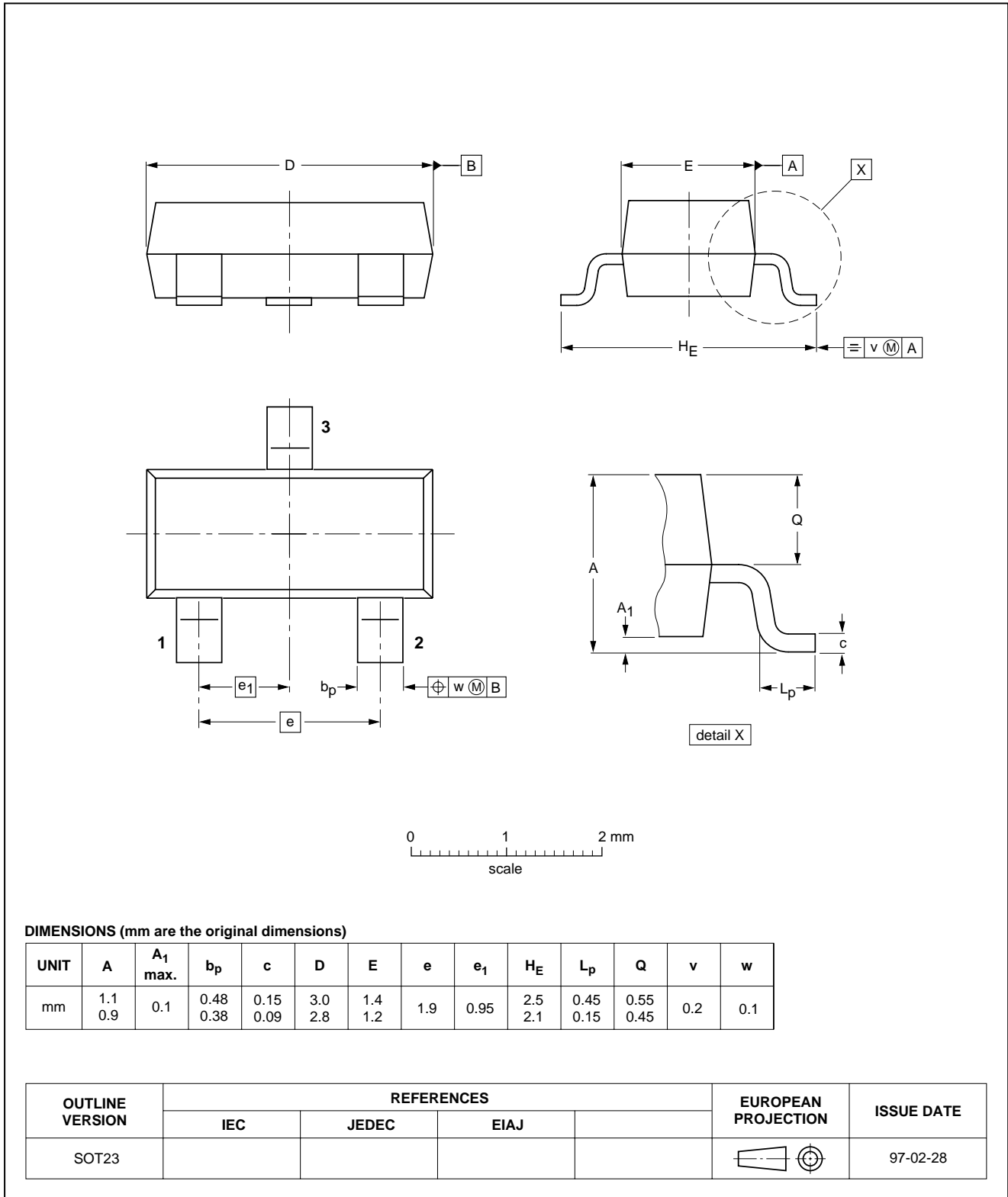

## High-speed double diode

PMBD7000

**DEFINITIONS**

<b>Data Sheet Status</b>	
Objective specification	This data sheet contains target or goal specifications for product development.
Preliminary specification	This data sheet contains preliminary data; supplementary data may be published later.
Product specification	This data sheet contains final product specifications.
<b>Limiting values</b>	
Limiting values given are in accordance with the Absolute Maximum Rating System (IEC 134). Stress above one or more of the limiting values may cause permanent damage to the device. These are stress ratings only and operation of the device at these or at any other conditions above those given in the Characteristics sections of the specification is not implied. Exposure to limiting values for extended periods may affect device reliability.	
<b>Application information</b>	
Where application information is given, it is advisory and does not form part of the specification.	

**LIFE SUPPORT APPLICATIONS**

These products are not designed for use in life support appliances, devices, or systems where malfunction of these products can reasonably be expected to result in personal injury. Philips customers using or selling these products for use in such applications do so at their own risk and agree to fully indemnify Philips for any damages resulting from such improper use or sale.



High-speed double diode

PMBD7000

---

**NOTES**

High-speed double diode

PMBD7000

---

**NOTES**

High-speed double diode

PMBD7000

---

**NOTES**

# Philips Semiconductors – a worldwide company

**Argentina:** see South America

**Australia:** 34 Waterloo Road, NORTH RYDE, NSW 2113,  
Tel. +61 2 9805 4455, Fax. +61 2 9805 4466

**Austria:** Computerstr. 6, A-1101 WIEN, P.O. Box 213,  
Tel. +43 1 60 101 1248, Fax. +43 1 60 101 1210

**Belarus:** Hotel Minsk Business Center, Bld. 3, r. 1211, Volodarski Str. 6,  
220050 MINSK, Tel. +375 172 20 0733, Fax. +375 172 20 0773

**Belgium:** see The Netherlands

**Brazil:** see South America

**Bulgaria:** Philips Bulgaria Ltd., Energoproject, 15th floor,  
51 James Bourchier Blvd., 1407 SOFIA,  
Tel. +359 2 68 9211, Fax. +359 2 68 9102

**Canada:** PHILIPS SEMICONDUCTORS/COMPONENTS,  
Tel. +1 800 234 7381, Fax. +1 800 943 0087

**China/Hong Kong:** 501 Hong Kong Industrial Technology Centre,  
72 Tat Chee Avenue, Kowloon Tong, HONG KONG,  
Tel. +852 2319 7888, Fax. +852 2319 7700

**Colombia:** see South America

**Czech Republic:** see Austria

**Denmark:** Sydhavnsgade 23, 1780 COPENHAGEN V,  
Tel. +45 33 29 3333, Fax. +45 33 29 3905

**Finland:** Sinikalliontie 3, FIN-02630 ESPOO,  
Tel. +358 9 615 800, Fax. +358 9 6158 0920

**France:** 51 Rue Carnot, BP317, 92156 SURESNES Cedex,  
Tel. +33 1 4099 6161, Fax. +33 1 4099 6427

**Germany:** Hammerbrookstraße 69, D-20097 HAMBURG,  
Tel. +49 40 2353 60, Fax. +49 40 2353 6300

**Hungary:** see Austria

**India:** Philips INDIA Ltd, Band Box Building, 2nd floor,  
254-D, Dr. Annie Besant Road, Worli, MUMBAI 400 025,  
Tel. +91 22 493 8541, Fax. +91 22 493 0966

**Indonesia:** PT Philips Development Corporation, Semiconductors Division,  
Gedung Philips, Jl. Buncit Raya Kav.99-100, JAKARTA 12510,  
Tel. +62 21 794 0040 ext. 2501, Fax. +62 21 794 0080

**Ireland:** Newstead, Clonskeagh, DUBLIN 14,  
Tel. +353 1 7640 000, Fax. +353 1 7640 200

**Israel:** RAPAC Electronics, 7 Kehilat Saloniki St, PO Box 18053,  
TEL AVIV 61180, Tel. +972 3 645 0444, Fax. +972 3 649 1007

**Italy:** PHILIPS SEMICONDUCTORS, Piazza IV Novembre 3,  
20124 MILANO, Tel. +39 02 67 52 2531, Fax. +39 02 67 52 2557

**Japan:** Philips Bldg 13-37, Kohnan 2-chome, Minato-ku,  
TOKYO 108-8507, Tel. +81 3 3740 5130, Fax. +81 3 3740 5077

**Korea:** Philips House, 260-199 Itaewon-dong, Yongsan-ku, SEOUL,  
Tel. +82 2 709 1412, Fax. +82 2 709 1415

**Malaysia:** No. 76 Jalan Universiti, 46200 PETALING JAYA, SELANGOR,  
Tel. +60 3 750 5214, Fax. +60 3 757 4880

**Mexico:** 5900 Gateway East, Suite 200, EL PASO, TEXAS 79905,  
Tel. +9-5 800 234 7381, Fax +9-5 800 943 0087

**Middle East:** see Italy

**Netherlands:** Postbus 90050, 5600 PB EINDHOVEN, Bldg. VB,  
Tel. +31 40 27 82785, Fax. +31 40 27 88399

**New Zealand:** 2 Wagener Place, C.P.O. Box 1041, AUCKLAND,  
Tel. +64 9 849 4160, Fax. +64 9 849 7811

**Norway:** Box 1, Manglerud 0612, OSLO,  
Tel. +47 22 74 8000, Fax. +47 22 74 8341

**Pakistan:** see Singapore

**Philippines:** Philips Semiconductors Philippines Inc.,  
106 Valero St. Salcedo Village, P.O. Box 2108 MCC, MAKATI,  
Metro MANILA, Tel. +63 2 816 6380, Fax. +63 2 817 3474

**Poland:** Ul. Lukiska 10, PL 04-123 WARSZAWA,  
Tel. +48 22 612 2831, Fax. +48 22 612 2327

**Portugal:** see Spain

**Romania:** see Italy

**Russia:** Philips Russia, Ul. Usatcheva 35A, 119048 MOSCOW,  
Tel. +7 095 755 6918, Fax. +7 095 755 6919

**Singapore:** Lorong 1, Toa Payoh, SINGAPORE 319762,  
Tel. +65 350 2538, Fax. +65 251 6500

**Slovakia:** see Austria

**Slovenia:** see Italy

**South Africa:** S.A. PHILIPS Pty Ltd., 195-215 Main Road Martindale,  
2092 JOHANNESBURG, P.O. Box 58088 Newville 2114,  
Tel. +27 11 471 5401, Fax. +27 11 471 5398

**South America:** Al. Vicente Pinzon, 173, 6th floor,  
04547-130 SÃO PAULO, SP, Brazil,  
Tel. +55 11 821 2333, Fax. +55 11 821 2382

**Spain:** Balmes 22, 08007 BARCELONA,  
Tel. +34 93 301 6312, Fax. +34 93 301 4107

**Sweden:** Kottbygatan 7, Akalla, S-16485 STOCKHOLM,  
Tel. +46 8 5985 2000, Fax. +46 8 5985 2745

**Switzerland:** Allmendstrasse 140, CH-8027 ZÜRICH,  
Tel. +41 1 488 2741 Fax. +41 1 488 3263

**Taiwan:** Philips Semiconductors, 6F, No. 96, Chien Kuo N. Rd., Sec. 1,  
TAIPEI, Taiwan Tel. +886 2 2134 2886, Fax. +886 2 2134 2874

**Thailand:** PHILIPS ELECTRONICS (THAILAND) Ltd.,  
209/2 Sanpavuth-Bangna Road Prakanong, BANGKOK 10260,  
Tel. +66 2 745 4090, Fax. +66 2 398 0793

**Turkey:** Yukari Dudullu, Org. San. Blg., 2.Cad. Nr. 28 81260 Umraniye,  
ISTANBUL, Tel. +90 216 522 1500, Fax. +90 216 522 1813

**Ukraine:** PHILIPS UKRAINE, 4 Patrice Lumumba str., Building B, Floor 7,  
252042 KIEV, Tel. +380 44 264 2776, Fax. +380 44 268 0461

**United Kingdom:** Philips Semiconductors Ltd., 276 Bath Road, Hayes,  
MIDDLESEX UB3 5BX, Tel. +44 181 730 5000, Fax. +44 181 754 8421

**United States:** 811 East Arques Avenue, SUNNYVALE, CA 94088-3409,  
Tel. +1 800 234 7381, Fax. +1 800 943 0087

**Uruguay:** see South America

**Vietnam:** see Singapore

**Yugoslavia:** PHILIPS, Trg N. Pasica 5/v, 11000 BEOGRAD,  
Tel. +381 11 62 5344, Fax.+381 11 63 5777

**For all other countries apply to:** Philips Semiconductors,  
International Marketing & Sales Communications, Building BE-p, P.O. Box 218,  
5600 MD EINDHOVEN, The Netherlands, Fax. +31 40 27 24825

**Internet:** <http://www.semiconductors.philips.com>

© Philips Electronics N.V. 1999

SCA 64

All rights are reserved. Reproduction in whole or in part is prohibited without the prior written consent of the copyright owner.

The information presented in this document does not form part of any quotation or contract, is believed to be accurate and reliable and may be changed without notice. No liability will be accepted by the publisher for any consequence of its use. Publication thereof does not convey nor imply any license under patent- or other industrial or intellectual property rights.

Printed in The Netherlands

115002/00/03/pp12

Date of release: 1999 May 11

Document order number: 9397 750 05925

*Let's make things better.*

**Philips**  
Semiconductors



**PHILIPS**

SUNSTAR 商斯达实业集团是集研发、生产、工程、销售、代理经销、技术咨询、信息服务等为一体的高科技企业，是专业高科技电子产品生产厂家，是具有 10 多年历史的专业电子元器件供应商，是中国最早和最大的仓储式连锁规模经营大型综合电子零部件代理分销商之一，是一家专业代理和分销世界各大品牌 IC 芯片和电子元器件的连锁经营综合性国际公司，专业经营进口、国产名厂名牌电子元件，型号、种类齐全。在香港、北京、深圳、上海、西安、成都等全国主要电子市场设有直属分公司和产品展示展销窗口门市部专卖店及代理分销商，已在全国范围内建成强大统一的供货和代理分销网络。我们专业代理经销、开发生产电子元器件、集成电路、传感器、微波光电元器件、工控机/DOC/DOM 电子盘、专用电路、单片机开发、MCU/DSP/ARM/FPGA 软件硬件、二极管、三极管、模块等，是您可靠的一站式现货配套供应商、方案提供商、部件功能模块开发配套商。商斯达实业公司拥有庞大的资料库，有数位毕业于著名高校——有中国电子工业摇篮之称的西安电子科技大学（西军电）并长期从事国防尖端科技研究的高级工程师为您精挑细选、量身订做各种高科技电子元器件，并解决各种技术问题。

微波光电部专业代理经销高频、微波、光纤、光电元器件、组件、部件、模块、整机；电磁兼容元器件、材料、设备；微波 CAD、EDA 软件、开发测试仿真工具；微波、光纤仪器仪表。欢迎国外高科技微波、光纤厂商将优秀产品介绍到中国、共同开拓市场。长期大量现货专业批发高频、微波、卫星、光纤、电视、CATV 器件：晶振、VCO、连接器、PIN 开关、变容二极管、开关二极管、低噪晶体管、功率电阻及电容、放大器、功率管、MMIC、混频器、耦合器、功分器、振荡器、合成器、衰减器、滤波器、隔离器、环行器、移相器、调制解调器；光电子元件和组件：红外发射管、红外接收管、光电开关、光敏管、发光二极管和发光二极管组件、半导体激光二极管和激光器组件、光电探测器和光接收组件、光发射接收模块、光纤激光器和光放大器、光调制器、光开关、DWDM 用光发射和接收器件、用户接入系统光收发器件与模块、光纤连接器、光纤跳线/尾纤、光衰减器、光纤适配器、光隔离器、光耦合器、光环行器、光复用器/转换器；无线收发芯片和模组、蓝牙芯片和模组。

更多产品请看本公司产品专用销售网站：

商斯达中国传感器科技信息网：<http://www.sensor-ic.com/>

商斯达工控安防网：<http://www.pc-ps.net/>

商斯达电子元器件网：<http://www.sunstare.com/>

商斯达微波光电产品网：[HTTP://www.rfoe.net/](http://www.rfoe.net/)

商斯达消费电子产品网：<http://www.icasic.com/>

商斯达实业科技产品网：<http://www.sunstars.cn/> 微波元器件销售热线：

地址：深圳市福田区福华路福庆街鸿图大厦 1602 室

电话：0755-82884100 83397033 83396822 83398585

传真：0755-83376182 (0) 13823648918 MSN: SUNS8888@hotmail.com

邮编：518033 E-mail:[szss20@163.com](mailto:szss20@163.com) QQ: 195847376

深圳赛格展销部：深圳华强北路赛格电子市场 2583 号 电话：0755-83665529 25059422

技术支持：0755-83394033 13501568376

欢迎索取免费详细资料、设计指南和光盘；产品凡多，未能尽录，欢迎来电查询。

北京分公司：北京海淀区知春路 132 号中发电子大厦 3097 号

TEL: 010-81159046 82615020 13501189838 FAX: 010-62543996

上海分公司：上海市北京东路 668 号上海赛格电子市场 D125 号

TEL: 021-28311762 56703037 13701955389 FAX: 021-56703037

西安分公司：西安高新开发区 20 所(中国电子科技集团导航技术研究所)

西安劳动南路 88 号电子商城二楼 D23 号

TEL: 029-81022619 13072977981 FAX:029-88789382